

# Safe cattle handling

**JULY 2014**



# **The purpose of these guidelines is to help reduce the risk of injuries and fatalities by providing practical guidance on safe cattle handling.**

---

## **ACKNOWLEDGEMENTS**

This guide was prepared by WorkSafe New Zealand, with help from a working group made up of representatives from:

- > Accident Compensation Corporation (ACC)
- > Beef and Lamb New Zealand
- > DairyNZ
- > Dairy Womens Network
- > FarmSafe
- > Federated Farmers of New Zealand Inc
- > Horticulture New Zealand
- > Landcorp Farming Ltd
- > Lincoln University
- > Ministry for Primary Industries
- > New Zealand Council of Trade Unions (NZCTU)
- > New Zealand Dairy Workers Union
- > New Zealand Transport Agency (NZTA)
- > Primary Industry Training Organisation
- > Rural Contractors New Zealand
- > Rural Women New Zealand
- > University of Auckland
- > University of Otago.

The guide has been largely adapted from an existing ACC publication: Handling Cattle Safely: No Bull Tips to Keep You Out of Trouble.

Information about animal welfare came from publications by the New Zealand National Animal Welfare Advisory Committee (NAWAC).

WorkSafe New Zealand also acknowledges the following organisations for providing information used to develop this guide:

- > WorkSafe Victoria (Australia)
  - > The Health and Safety Authority (Ireland)
  - > The National Farm Animal Care Council (Canada).
-

# **SAFE CATTLE HANDLING: KEY POINTS**

---

**Anyone working with cattle must be appropriately trained and experienced for the task**

---

**Keep yards tidy and well maintained**

---

**Plan an escape route in advance when working with cattle in the yards**

---

**Never get in the race with large cattle. Don't put your arms or legs through the race walls**

---

**Don't try to move a dangerous bull on foot or alone**

---

**Always wash and dry your hands after working with cattle**

---

# TABLE OF CONTENTS

---

<b>01</b>	<b>INTRODUCTION</b>	<b>4</b>
1.1	Purpose	5
1.2	Scope	5
1.3	Development	5
<b>02</b>	<b>CATTLE HANDLING PRINCIPLES</b>	<b>6</b>
2.1	Keep cattle calm	7
2.2	Recognising danger signs	7
2.3	Use gentle handling	8
2.4	Learn the 'flight zone'	8
2.5	Balance lines	9
2.6	Use your voice	9
2.7	Use a waddy	10
2.8	Be firm	10
2.9	Avoid getting kicked	10
2.10	Wear the right gear	10
2.11	Bulls	11
<b>03</b>	<b>GUIDANCE FOR SPECIFIC SITUATIONS</b>	<b>12</b>
3.1	Mustering	13
3.2	Working with cattle in the yards	13
3.2	Cows with calves	15
3.3	Lifting calves	16
3.4	Moving bulls	16
3.5	Drenching	17
3.6	Working cattle through the race	17
3.7	Drafting through a race	18
3.8	In the crush	18
3.9	Ear tagging	19
3.10	Injecting/vaccinating	19
3.11	Dehorning	20
3.12	Castration	20
3.13	Loading and unloading	26
3.14	Farm dairies	21
3.15	Zoonoses	21

<b>04</b>	<b>PRINCIPLES OF SAFE CATTLEYARD DESIGN</b>	<b>23</b>
4.1	The site	24
4.2	Orientation	24
4.3	The benefits of steel yards	24
4.4	Lighting	24
4.5	Yard Surface	24
4.6	Pens	25
4.7	Race, crush and head bail	26
4.8	Loading	26
4.9	Keep up your maintenance plan	26
4.10	Plan long-term improvements	27
<b>05</b>	<b>TRAINING REQUIREMENTS</b>	<b>28</b>
5.1	General requirements	29
5.2	Children	29
5.3	Training for health and safety representatives	29
<b>07</b>	<b>REFERENCES</b>	<b>30</b>
7.1	Glossary	31
7.2	Bibliography	33

## FIGURES

<b>1</b>	Common head positions	7
<b>2</b>	Common tail positions	8
<b>3</b>	Flight zone	8
<b>4</b>	Balance lines	9
<b>5</b>	Using flags	15
<b>6</b>	How to lift a calf	16
<b>7</b>	Working cattle through a race	17
<b>8</b>	Slip-rail hazard	18
<b>9</b>	Inverted hinge	25
<b>10</b>	Pen with boarded out corner; Access gap	25
<b>11</b>	Catwalk	26

# 01/

---

## INTRODUCTION

---

### IN THIS SECTION:

- 1.1 Purpose
- 1.2 Scope
- 1.3 Development

---

## This publication is a guide to handling cattle safely.

---

### 1.1 PURPOSE

The guide outlines the potential hazards involved in handling cattle and gives recommendations on how to eliminate, isolate and minimise those hazards. WorkSafe NZ accepts these recommendations as current industry good practice. They will help you comply with the Health and Safety in Employment Act 1992 (the HSE Act).

Cattle have minds of their own, a huge weight advantage and move surprisingly fast. Agitated cattle are a particular risk. It takes skill and practice to handle them safely. Even skilled cattle handlers take knocks or kicks during their careers.

Every year, many people are hurt by cattle, mostly when cattle kick or crush them. Some get serious injuries, like broken bones, and people have been killed.

You are more likely to be injured:

- > when you don't have the experience to assess the risks
- > when you don't have the agility or ability to get out of the way
- > with bulls
- > with recently calved cows
- > with bad-tempered or irritable cattle
- > with cattle that are not handled by humans very often, eg run cattle

- > in a new environment for cattle, eg entering the milking shed for the first time
- > handling cattle at close quarters, like in a race or a crush
- > loading and unloading cattle for transport
- > when you are tired, like during calving season when farmers work long hours with broken sleep.

Older farmers (over 65 years) and children are most at risk of injury.

### 1.2 SCOPE

This guide applies to anyone handling cattle, including farmers, farm employees, contractors and truck drivers. It applies to both the beef and dairy industries.

### 1.3 DEVELOPMENT

Industry experts helped WorkSafe NZ develop this guide. WorkSafe NZ also thoroughly reviewed accident statistics and published academic literature, and looked at how overseas health and safety regulators manage the same issues.

WorkSafe NZ has made every effort to make sure the guide's recommended hazard controls reflect current good practice.

# 02/

---

## **CATTLE HANDLING PRINCIPLES**

---

### **IN THIS SECTION:**

- 2.1 Keep cattle calm**
- 2.2 Recognising danger signs**
- 2.3 Use gentle handling**
- 2.4 Learn the 'flight zone'**
- 2.5 Balance lines**
- 2.6 Use your voice**
- 2.7 Use a waddy**
- 2.8 Be firm**
- 2.9 Avoid getting kicked**
- 2.10 Wear the right gear**
- 2.11 Bulls**



## This section outlines principles for handling cattle safely.

### 2.1 KEEP CATTLE CALM

Alarmed and over-excited cattle are dangerous. Give them time to settle down, particularly when they've just been moved into the yards. They'll be a lot easier and safer to work with.

Some things upset cattle and other things calm them down. Understanding these will make your job easier.

WHAT UPSETS CATTLE?	WHAT CALMS CATTLE DOWN?
Being hungry and/or thirsty	Working with them in a quiet, confident way
Loud noise - dogs barking, shouting, motorbikes revving	Familiarity and familiar people
Being hit or beaten	Gentle, low sounds
Electric prodders - use them sparingly, especially in restricted areas or on bulls.	Rhythmical sounds
Painful, new or strange objects	Talking quietly to the animals
Being chased	Stroking
People in their 'personal space', particularly around the head	Silence
Sickness or injury	

### 2.2 RECOGNISING DANGER SIGNS

Agitated cattle often bellow loudly and paw the ground with their hooves. The head and tail positions of cattle also give clues as to the animal's state of mind. Be on the lookout for these danger signs.

Common head positions:

1. Neutral position
2. Slightly antagonistic position
3. Highly antagonistic position
4. Confident approach
5. Submissive approach
6. Alert before flight position

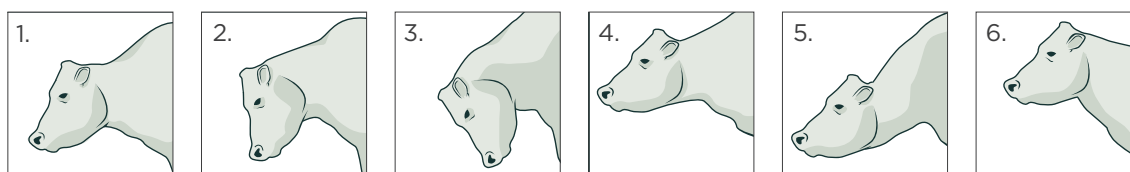

Figure 1: Common head positions

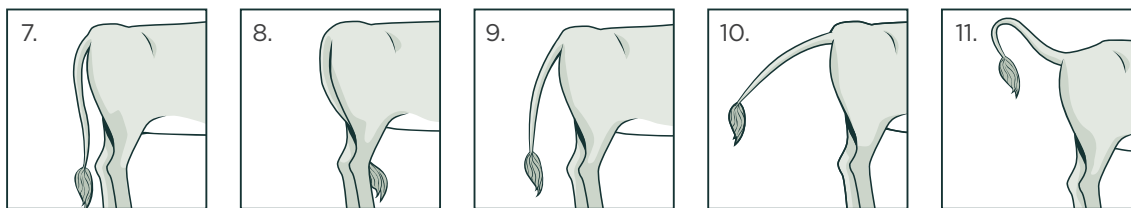

Figure 2: Common tail positions

Common tail positions:

7. Grazing or walking
8. Cold, ill or frightened
9. Threatening, curiosity or sexual excitement
10. Galloping
11. Kicking or playing

### 2.3 USE GENTLE HANDLING

Cattle have good memories. They learn quickly and they soon work out who frightens them and who treats them well. Sometimes they will get stressed, such as during castration, weaning and the first milking. If you treat them gently at those times, it'll pay off in the future.

### 2.4 LEARN THE 'FLIGHT ZONE'

The 'flight zone' is the term for how close you can get to cattle before they start moving.

The flight zone can be 5 metres or less for regularly-handled dairy cattle. A herd of beef cattle that have been handled infrequently will start moving if you get within 100 metres.

Entering the cattle's flight zone will get them moving. The closer you get, the faster they will move away. Manage their movement speed by how close you get to them. Likewise, to stop them moving, step out of their flight zone.

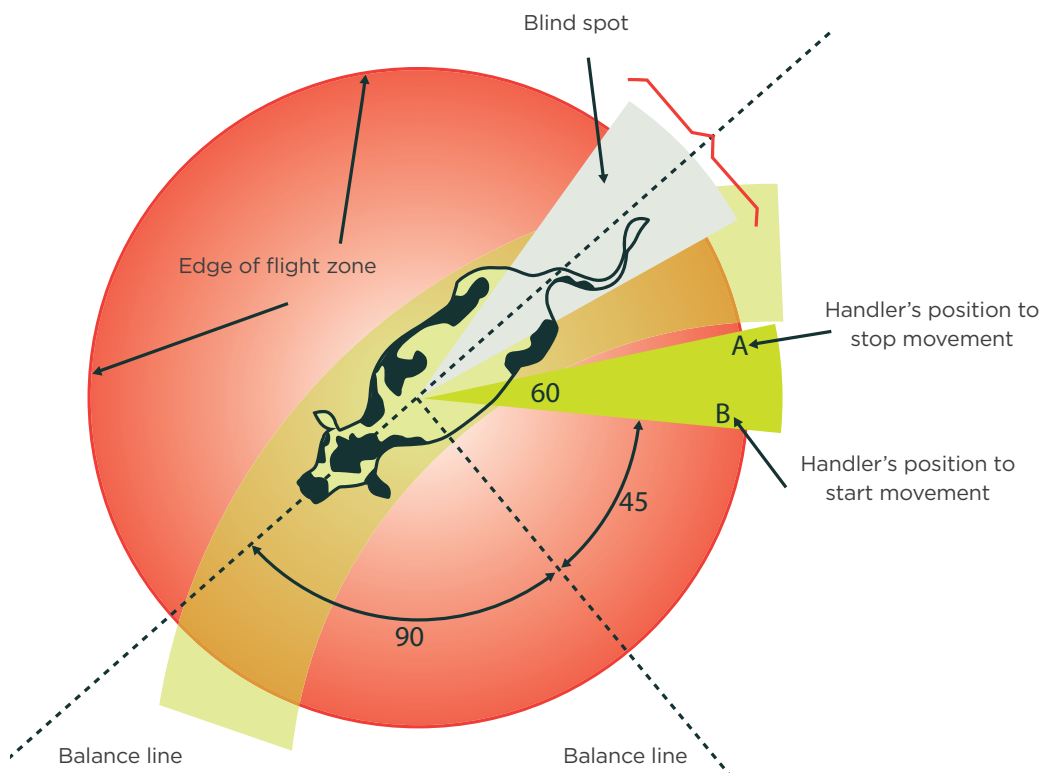

Figure 3: Flight zone

## 2.5 BALANCE LINES

Cattle have two balance lines. One runs across the shoulders and the other runs along the backbone. When you're working up close, whichever way you move through those lines, the animal will move the other way:

- > If you're alongside the animal and move forward, it will move backward.
- > If you go back, it will go forward.
- > If you're in front and move to the left, it will move to your right.

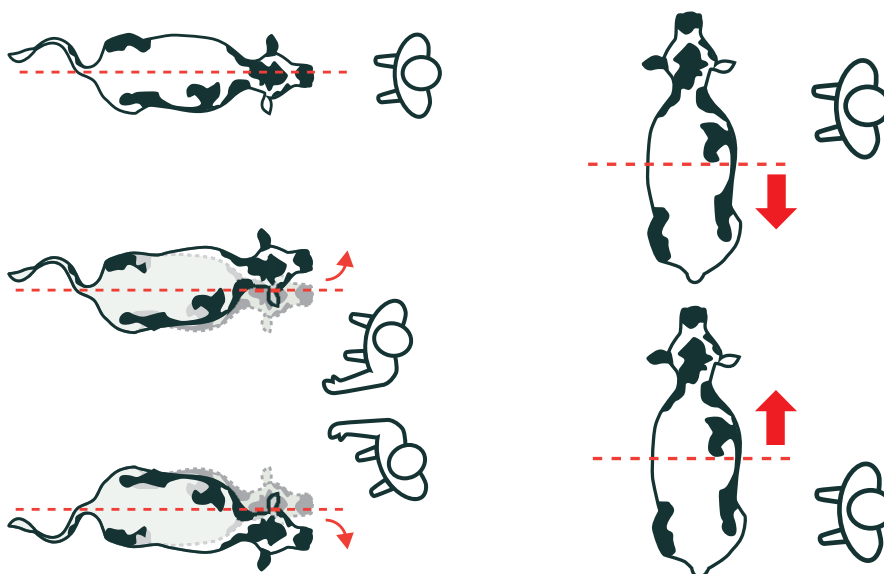

Figure 4: Balance lines

## 2.6 USE YOUR VOICE

Your voice is a useful cattle handling tool. Good cattle handlers use their voices to calm and soothe. Most importantly, your voice lets the cattle know where you are.

Cattle can't see the way we can. The cow's eyes, on either side of their head, give them a wide range of vision. But when they look at something with one eye, they can't work out distances. They can't see directly behind at all.

If they detect movement to the side or the rear, they will spook. But if they can hear you, they know where you are and are more likely to feel calmer.

## 2.7 USE A WADDY

Carry a length of pipe or a long stick (a waddy). Put a piece of cloth on the end to make a flag. A waddy makes you look bigger. It may also give you confidence when handling difficult animals.

If you stand facing the cow with your waddy outstretched, you're domineering and positive. If you want to take pressure off – for example, when a bull is giving you a dirty look – you can take the heat out of the situation by lowering the waddy and turning side-on.

## 2.8 BE FIRM

A human is one of three things to cattle:

1. a predator to run away from
2. a 'nobody' to ignore
3. a dominant figure needing respect.

You don't want to be a predator, and you definitely don't want to be a nobody. So you need to show authority and confidence.

While a tap on the nose or back with your waddy or hand can get cattle moving along a race, only do it sparingly. Hitting cattle frightens them and makes them dangerous and harder to work with. The person doing it is clearly not in control.

The most dominant animals always stick to the middle of the mob, so putting pressure on the tail-enders is pointless. Dominant animals will turn on inferior animals if the inferior ones push them, adding to the problem. Find out why an animal will not move and deal with it.

Only use electric prodders as a last resort for handling cattle. Do not use the prodder on an animal that has no room to move forward. Do not use the prodder on an animal for more than one second at a time, and for no more than five times in a row. Give every animal an adequate break after each time you use the prodder. Do not use an electric prodder on sensitive areas, including the udder, eyes, nose, anus, vulva or testicles. Only use electric prodders on adult cattle.

Don't chase cattle. They'll see you as a predator and fear you. Avoid this particularly with young dairy cattle because you need to handle them frequently. Instead, walk confidently and quietly toward them.

## 2.9 AVOID GETTING KICKED

Never underestimate the speed, power or accuracy of a kick from cattle. Either stand well back and out of range or, when you're working close, turn side-on and get in very close. If there's space between you and the animal, the kick will speed up before it hits you.

## 2.10 WEAR THE RIGHT GEAR

Leather boots with steel toe-caps are best. Gumboots should have toe-caps. A strong pair of trousers and leggings softens the severity of kick injuries. Take off your wristwatch and loose jewellery, and roll your sleeves down in case you're rubbed against fences or timber.

## 2.11 BULLS

Accidents, some fatal, happen every year because of bulls. A bull can kill you when he is being playful just as easily as when he is angry.

Bulls are more dangerous the older they get. Never trust a bull – particularly the ‘lone bull’ reared or kept in isolation.

Never turn your back on a bull.

Avoid handling bulls alone, particularly if you are not as fast or agile as you could be, whether through age or injury. There are logical exceptions, such as excellent bull facilities where no direct contact is needed.

If you get cornered by a bull, shout loudly and strike it repeatedly on the nose with a waddy to make it close its eyes, then get out of there as fast as you can.

If you’re trying to get a bull, or cattle, away from an injured person, make lots of noise, use your waddy and don’t put yourself in harm’s way. Shout for help.

Use vehicles, such as a tractor or ute, when dealing with bulls in the paddock. These are better than working on foot, a quad bike or two-wheeled motorbike.

Securely fence bull paddocks and keep gates in good condition. If possible, avoid grazing a bull in a field that children or the public could access.

Use bulls that produce docile offspring. In all cases, without exception, send aggressive bulls to slaughter. Don’t sell your problem animals to another farmer.



# 03/

## **SPECIFIC HAZARDS AND CONTROLS**

---

### **IN THIS SECTION:**

- 3.1 Mustering**
- 3.2 Working with cattle in the yards**
- 3.2 Cows with calves**
- 3.3 Lifting calves**
- 3.4 Moving bulls**
- 3.5 Drenching**
- 3.6 Working cattle through the race**
- 3.7 Drafting through a race**
- 3.8 In the crush**
- 3.9 Ear tagging**
- 3.10 Injecting/vaccinating**
- 3.11 Dehorning**
- 3.12 Castration**
- 3.13 Loading and unloading**
- 3.14 Farm dairies**
- 3.15 Zoonoses**

---

The most common cattle handling hazards are set out on the following pages. Guidance is provided about ways to effectively control these hazards.

---

### 3.1 MUSTERING

Mustering cattle is hazardous. If cattle get worked up, they can run into and over people, causing serious injuries and death. Another hazard is using two-wheeled motorbikes or quad bikes during mustering. Riding a bike when your attention is divided (eg focusing on the stock and not where you're going) increases the chance of an accident.

#### MANAGING THE HAZARD:

Prepare the route in advance. Open the gates and work out where the cattle are likely to break away so you can be on guard. Use the cattle handling principles outlined in this guide.

- > Muster early in the morning or towards nightfall when the temperatures are cooler and the animals have been grazing for a while.
- > Use the flight zone to move them. Stay on the fringes and to one side so they don't panic and scatter.
- > Only use well-trained dogs for cattle work. Use them for mustering, but tie them up once the cattle are in the yards.
- > Move cows and calves slowly and handle them gently. Look out for aggressive mother cows. Try to avoid mustering beef cows with young calves.
- > When closing a yard gate behind a mob of cattle, try to stand to the side. If you have to be behind the gate, hang on with both hands and use your boots to provide support in case an animal flings the gate backwards.

When using a motorbike for mustering cattle, drive slowly and seek terrain where you can clearly see hazards or obstructions. Always wear a helmet.

Select the best vehicle for the job considering the task and terrain. Remember that two-wheeled motorbikes and quad bikes need your full attention to balance and control.

### 3.2 WORKING WITH CATTLE IN THE YARDS

Many injuries happen in the yards. Working with cattle in the yards is hazardous – the cattle are in a restricted space and more agitated than normal. They can crush people against rails and fences, trample over fallen people or step on toes.

Factors that increase the risks are:

- > agitated cattle
- > inexperienced handlers – cattle recognise fear and may react unpredictably
- > new or infrequently handled cattle – cattle can be more difficult to handle if it's their first time in the yards, they're in new yards or with different handlers
- > poorly designed or maintained yards.

#### MANAGING THE HAZARD:

Before yarding cattle, make sure the yards are properly set-up and free of rocks, rubbish and other debris. Remove any sharp objects that could injure or frighten people and livestock.

GOOD PRACTICE GUIDELINES // SAFE CATTLE HANDLING

Rocks, rubbish and debris can cause tripping injuries and may upset the movement of stock throughout the yards.

Too much mud is a slipping hazard for cattle and humans. If possible, remove this before using the yards.

Before you take cattle into the yards (especially yards you haven't worked in before), check:

- > the fences and catwalks are in good condition
- > there are no bolts or broken rails sticking out
- > the layout and know how things work
- > the head bail works smoothly and can adjust for the size of cattle
- > that gates latch and they can open or close quickly
- > the yard is well lit, or there are torches for night work
- > that rear race gates are used.

Safety in cattle yards improves with well-designed and kept yards. Before yarding cattle ensure the fences and catwalks are in good condition and check there are no protruding bolts or broken rails. See the section 'Principles of Safe Cattle Yard Design' for more information.

Before working with cattle, try to leave them in the yards for about 30 minutes so they can calm down.

Cattle are easier to handle once they have settled down after mustering and have become familiar with the yards. Give them water during this time if possible.

When handling cattle in the yards, keep them calm.

- > Limit loud noises like shouting, barking dogs and revving motorbikes.
- > Practice using a constant voice in a soothing tone to let the cattle know where you are, and lower the chances of you surprising and frightening them.
- > Don't chase or beat cattle and limit the use of prodders.
- > Try to stay out of an animal's 'personal space' around its head.
- > Don't have too many cattle in the yard at once.
- > Don't leave an animal on its own; cattle are herd animals and are much easier to move and handle if they are with other cattle, or can at least see another animal.
- > Hungry cows may be more agitated.

Use good cattle-handling techniques.

- > Use the flight zone and balance lines to make cattle move in the direction you want.
- > Use a waddy or flag.
- > Watch what's happening around you.
- > In dangerous situations, turn side-on to cattle. It makes you look smaller and less threatening. Get out of the pen as soon as it's safe to do so.
- > Close gates behind you so other animals can't enter unexpectedly.

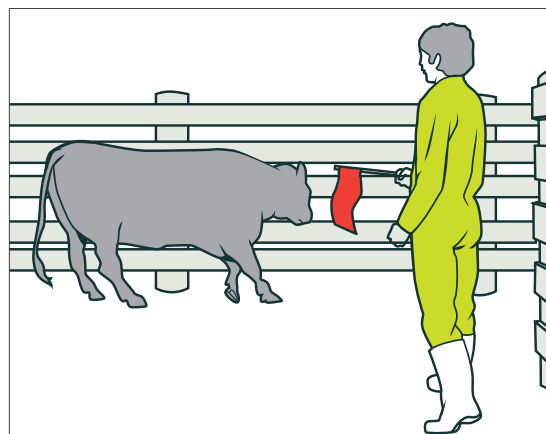

Figure 5: Using flags



SECTION 3.0 // SPECIFIC HAZARDS AND CONTROLS

Use two cattle handlers for moving and drafting beef cattle in the yards.

Plan an escape route before you need it.

Always have a plan to escape from potentially dangerous situations if you need to. Well-designed yards should have escape points.

Wear steel-capped boots when working in cattle yards.

Steel-caps can prevent broken or bruised toes if cattle stand on them. Long sleeves and trousers can protect you if you're rubbed against the rails or kicked.

### 3.3 COWS WITH CALVES

Farmers can suffer serious injuries while attending cows at calving time. Cows can become agitated if they feel their calves are threatened, putting handlers at risk. Any cow, although beef cows especially, can be aggressive at this time. A heifer that has just calved may be more threatening.

The younger the calf, the more dangerous the mother. Taking a newborn calf from a cow, hand milking a cow and navel dipping a calf are hazardous jobs.

The following increase your risk of injury:

- > Getting between the calf and the mother without a barrier or other protection, especially when weighing or ear-tagging a newborn calf.
- > Dogs irritating cows with calves, making the cows aggressive.
- > A bellowing calf agitating the mother.
- > Long hours and regular night work making you tired, leaving you less aware of an aggressive cow and how to respond to it.

#### MANAGING THE HAZARD:

If you have to catch a calf, keep it between you and the mother. Try to keep a fence or vehicle between you and the cow.

- > Keep the calf quiet by holding its mouth shut.
- > Don't work cows and calves with dogs unless the dogs are well trained. Restrain untrained dogs until cattle stop moving.

When moving cows with calves:

- > Give the cows time to mother-up with their calves before moving.
- > Use trained or experienced staff. Work in pairs and communicate regularly.
- > Move cows and calves slowly.

### 3.4 LIFTING CALVES

Lifting calves results in many back injuries to farmers.

#### MANAGING THE HAZARD:

Avoid lifting calves if possible. If you have to lift a calf, use your legs and keep your back as straight as possible.

As calves grow they quickly become very heavy. Only physically fit and strong people should lift calves. No one should lift a calf if it is too heavy for them.

To lift, squat beside the calf, pull it in close with one arm around the front and the other around the hind legs. Straighten your knees to lift it. Hold it firmly – don't let it struggle loose.

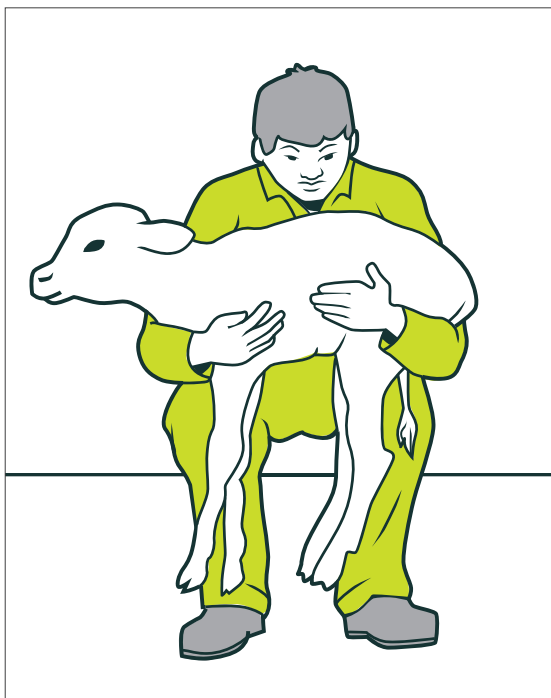

Figure 6: How to lift a calf

### 3.5 MOVING BULLS

Bulls can be dangerous, particularly if aggressive. Even apparently quiet bulls can kick, crush or gore people to death easily.

Factors increasing the risk:

- > Older bulls: a bull's temperament changes as it ages, from a playfully aggressive yearling to defensive, territorial aggression as a 2-3 year old.
- > Lone bulls reared or kept in isolation can be very dangerous.
- > Bulls are more aggressive during mating season.
- > Bulls are more dangerous when there are other bulls around.
- > Bulls are extremely dangerous when fighting.
- > Farmers with reduced mobility and speed are more at risk.

### MANAGING THE HAZARD:

Don't try to move a dangerous bull on foot or alone. Use a ute or tractor, get someone to help, use a well-trained dog, or bring the bull along with a group of steers or cows to help keep it calm.

- > Move confidently, but carefully. You must show dominance.
- > Keep bulls moving at a trot until they're well into the paddock and clear of the gate. Keep them a good distance apart.
- > Stay clear of a fighting pair.
- > Always have a waddy and be ready to use it.
- > If cornered by a bull, don't move too fast. Slowly move out of the bull's 'flight zone'. Turning and running from the bull invites being chased and they are usually faster. If there is no escape route, step sideways out of his best vision. This will confuse him.

### 3.6 DRENCHING

Drenching involves working close to cattle. They can knock you, kick you, step on your feet and crush you against the side of the race. Drenching cattle in the race is hard work. You need physical strength and might receive musculoskeletal injuries.

### MANAGING THE HAZARD:

Use a pour-on with large cattle if you can. Apply it close to the animal to reduce splash. Do not get it on your skin.

- > Where pour-on cannot be used, drench animals by leaning over the rail and holding their heads, rather than getting in the race with them - or use a head bail.
- > Approach the head from the side (not the front), run your hand from the neck under the ear and along the jawbone, then cup the jaw in your hand. Keep your head away from the animal's head in case it jerks up.

- > Drench smaller cattle in the race by packing them in tight. Work from the front to the back and wear boots with steel toe-caps.
- > Make sure anyone doing this work has the size and strength needed to work safely.
- > Try to make the experience as pleasant as possible or the cattle will resist next time.
- > Work quietly and with confidence.

### 3.7 WORKING CATTLE THROUGH THE RACE

Cattle are large, powerful animals. You are very close to them when you work them through a race. Hazards involve getting rolled or crushed along the side of the race, crushed feet, and broken or bruised arms if trapped between moving cattle and fixed objects.

#### MANAGING THE HAZARD:

Never get in the race with large cattle. Don't put your arms, head or legs through the race walls.

- > Work with a partner if you can.
- > Don't overfill the forcing pen. Make sure the cattle have room to turn towards the race mouth.
- > Pack the race firmly to stop the cattle moving back and forth.
- > If there's a safe and well-maintained catwalk, use it.
- > To get the cattle moving forward, walk along the catwalk or just inside the flight zone from the front of the race to the back.

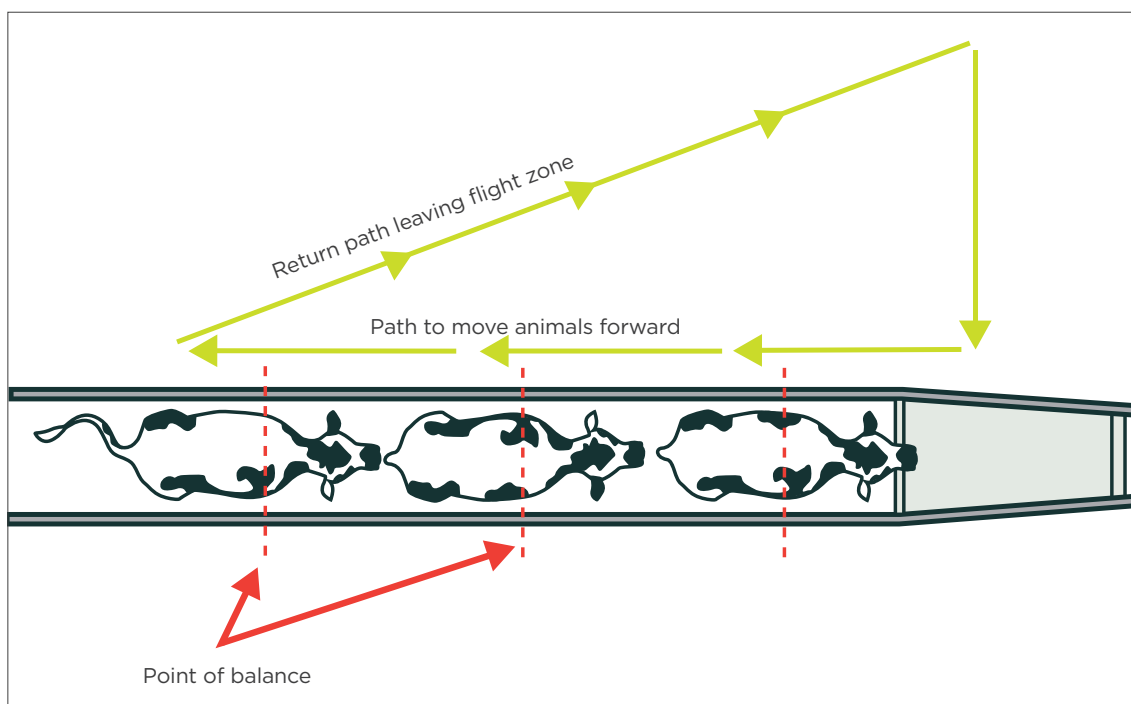

Figure 7: Working cattle through a race

### 3.8 DRAFTING THROUGH A RACE

Effective drafting depends on a steady line of cattle moving up the race with steady pressure from behind. The person controlling the drafting gate has to work closely with the cattle. Cattle can hit body parts if they are in the race, causing bruising, twisting and straining injuries.

#### MANAGING THE HAZARD:

Try to keep body parts out of the race.

- > Draft quiet cattle away from more excitable stock, eg cows from bulls, cows from calves, old from young.
- > Draft in small mobs of up to 50. The pens should be half full so there's room for movement, but not for scattering.
- > If you make a mistake, fix it at the end of the draft.
- > When you've finished drafting, keep the two mobs where they can see each other.

This helps settle them.

### 3.9 IN THE CRUSH

When working up close with cattle, their sudden movements can jerk your arms or crush you.

Slip rails and hock bars can be dangerous. The bars can be easily knocked forward, back or up.

#### MANAGING THE HAZARD:

Never stand in front of a bar used as a slip rail or hock bar behind the last animal. Always stand at the end of the bar, and keep it at arm's length in case it jerks upward.

- > Beware of sudden movements that could crush your arms or hands.
- > Restrain an animal in a head bail and use a head restraint if working on the head.
- > Take care when using brands or knives when castrating. Consider wearing chain mail gloves.
- > Beware when opening side gates on a crush. An animal's weight can force the gate into you.

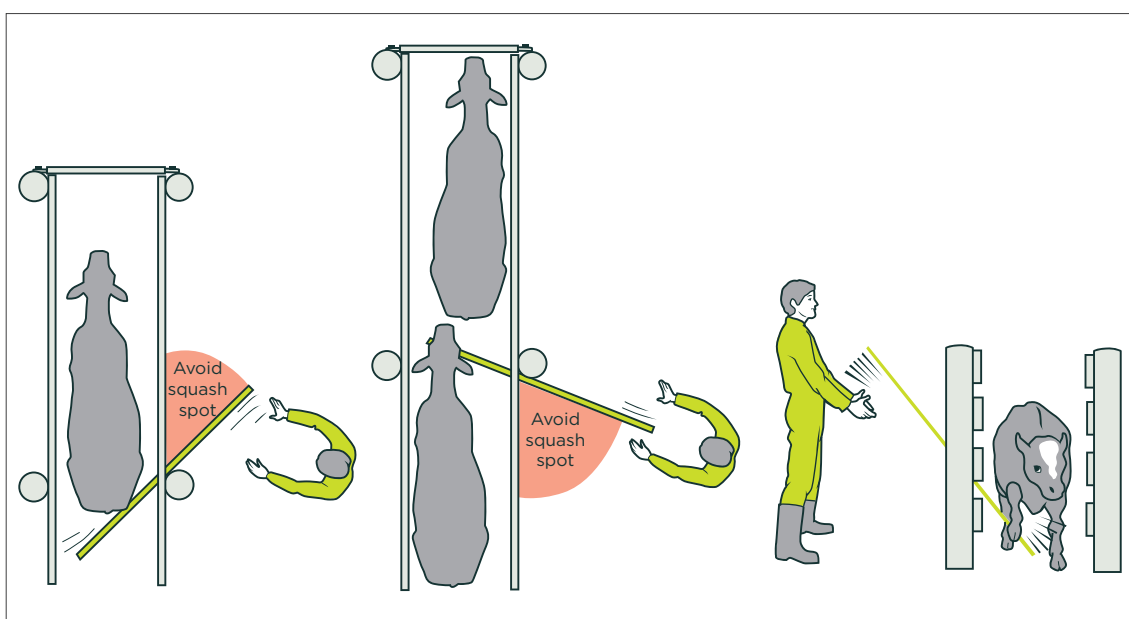

Figure 8: Slip-rail hazard

### 3.10 EAR TAGGING

Inserting cattle tags is risky because cattle neck muscles are much stronger than your arms. Ear tagging is painful for cattle. If your arms are in the wrong place and an animal's head suddenly jerks, this can throw your shoulder out or crush your hands and arms against solid objects. Horn stubs are also hazardous.

#### MANAGING THE HAZARD:

Always work from above the animal's head – never through the rails. For difficult animals and bulls, use a head bail.

- > Make sure only people with enough strength do this job.
- > Have the right applicator for the type of tag you are using. Make sure it's in excellent condition – if it's faulty, replace it before you start.
- > Avoid hitting the cartilage ridges or major blood vessels when putting an ear tag in. This limits the pain and distress to the animal and they are less likely to jerk their head and cause injury to the ear-tagger.
- > Only do ear tagging in dry conditions. This reduces the chance of your feet slipping and helps the wound dry.
- > Pack the cattle tightly.
- > Check that the race is strong enough for the job. You don't want the rails collapsing during the job.
- > Try to get all their heads up before you start the job.
- > Take extra care if a cow has horn stubs.
- > Work quickly once you are ready to insert the tag. Be alert for sudden head movements.
- > Get the job over quickly so the cattle are confined for only a short time.

### 3.11 INJECTING/VACCINATING

Sharp needles are used for vaccination. This means that you risk injecting yourself instead of the animal.

Cattle can also suddenly react and hit handlers, twist their arms or crush them against solid objects. This is more likely to happen if the animal is not properly restrained.

#### MANAGING THE HAZARD:

Some vaccinations are dangerous to humans and should only be done by a veterinarian, eg vaccinating heifers for leptospirosis and toxoplasmosis. Farmers who want to do vaccinations themselves should learn techniques under supervision until they are competent.

If the cattle are tightly packed, you may be able to vaccinate from above the top rail. Otherwise, restrain the cattle in the crush and (if necessary) get a second person to hold the head.

To vaccinate:

- > use sharp needles that are the correct size
- > make sure there is no air in the needle
- > follow the label instruction for dose level
- > place your hand with the syringe or vaccinating gun against the neck
- > 'tent the skin' for an injection that goes under the skin (subcutaneous injection)
- > insert the needle
- > twist the needle hand as you press down on the plunger.

Place needles in a sharps container with a lid and dispose of them correctly.

### 3.12 DEHORNING

Cattle with sharp horns are dangerous. They use their horns aggressively, which poses a greater risk to handlers.

Dehorning reduces injuries to workers and other animals. Meat works usually want dehorned (or shortened) cattle because it keeps carcass bruising to a minimum.

The simplest way to get rid of cattle horn hazards is to use polled breeds (breeds that don't have horns) or disbud calves between 2 and 6 weeks of age.

Disbud calves or use polled breeds.

Dehorning causes a lot of pain for older cattle and may make them react suddenly and violently. They can turn and attack when the handler lets the animal out of the head bail.

#### MANAGING THE HAZARD:

Never dehorn large cattle when you're alone in the race.

- > Use a good head bail and a nose bar.
- > Stand well clear when you let the animal out, as it could turn and attack.

The Animal Welfare (Painful Husbandry Procedures) Code of Welfare 2005 requires pain relief for dehorning cattle over 9 months old. A qualified vet should do this.

### 3.13 CASTRATION

Castrating male beef cattle reduces aggression and makes handling easier.

Unless the farm specifically raises bulls for breeding or beef, castrate all bull calves.

All castration methods cause pain and distress. Minimise this by castrating as early as possible, preferably within the first week of life.

The simplest castration method is to place rubber rings on calves under a month old with an elastrator. This reduces the calf's stress and is the safest method for the farmer.

The Animal Welfare (Painful Husbandry Procedures) Code of Welfare 2005 states that bulls over six months old must not be castrated without pain relief. A qualified vet should do this.

#### MANAGING THE HAZARD:

Castrate cattle as young as possible.

Consider using chain mail gloves to protect hands from kicks, especially when using knives for castration.

### 3.14 LOADING AND UNLOADING

Many injuries happen when loading and unloading cattle. Cattle usually don't like being loaded onto a trailer and some will resist. They need time to look at and work out how to move into new environments. If they are pushed too fast, they will baulk and become more difficult to handle.

Loading and unloading also involves working in tight spaces with cattle. If they get upset they can kick, charge and crush handlers.

#### MANAGING THE HAZARD:

Keep the loading ramp and race in good working order. Make sure the animals are fit for transport and loaded correctly.

- > Make sure a suitable loading ramp is available.
- > Do not get directly behind cattle.
- > Use all the available gates to stop the cattle backing up.

SECTION 3.0 // SPECIFIC HAZARDS AND CONTROLS

- > Walk down the ramp or catwalk to encourage the animals to go up (and vice versa) as shown in Figure 7.
- > Driving the mob from the rear won't speed up loading – the dominant cattle in the middle won't be pushed along by the tail-enders.
- > Give the cattle time to unload – they will follow each other.

Stand stock off green feed for at least 4 hours (but no more than 12 hours) to stop effluent spilling onto roads during transport. Make sure cattle have water during this time. It is best not to hold them on concrete. A grazed out paddock or properly prepared stand-off pad will reduce the incidence of sore legs, feet and subsequent lameness.

### 3.15 FARM DAIRIES

Injuries happen when moving dairy cows in and out of the dairy, and cattle may kick during milking. The chances of injury increase if cattle are irritated, afraid or angry.

Dairy cows are normally handled daily so they know the process and pose fewer risks. But cows may be scared or worried if:

- > they're hurt because of unsafe facilities (eg poorly placed neck rails, poor flooring, obstacles)
- > a dominant cow approaches another cow or an animal or person invades their personal space
- > the cow does not cope with the equipment or facility (eg poor lighting, noise from air-operated gates, slippery floors, stray electrical charges)
- > they're unwell (eg due to ryegrass staggers)
- > the animals are not frequently handled
- > the cow has recently calved
- > the work involves jobs like veterinary work.

#### MANAGING THE HAZARD:

Install kick rails in the milking shed. Stay behind the kick rails wherever possible.

- > Make sure the work is only done by experienced people who know the hazards and how to avoid them.
- > Make sure that heifers new to the milking herd – which may be less familiar with noises, activity and people – get used to the shed before their first milking.
- > Don't leave young stock (ie heifers) by themselves on the rotary platform, especially if it is not moving, as they become easily agitated.
- > Cull animals that are often aggressive or hard to handle. If this is not an option, make sure equipment and work systems can deal with the animal. Let staff and other people, like vets, know the potential problems.

For more information, refer to WorkSafe NZ's Good Practice Guidelines for Staying Safe in and Around Farm Dairies.

### 3.16 ZOONOSES

Zoonoses are diseases that people can catch from animals. They can cause mild to deadly human health problems. People working with livestock can be exposed to these diseases.

The main diseases humans catch from cattle are: acariasis, campylobacter, cryptosporidiosis, E. coli, leptospirosis, listeriosis, milkers' nodules, ringworm, salmonella and streptococcus.

You can be exposed to zoonotic diseases by:

- > getting animal blood, urine or faeces splashed in your eyes, nose or mouth
- > having bugs enter your bloodstream through cracked skin or open cuts
- > breathing in dust or micro-organisms
- > eating or drinking infected animal products
- > being bitten by flies, mosquitos, ticks or fleas that have also bitten infected animals.

#### MANAGING THE HAZARD:

Avoid catching diseases from animals through good health and hygiene practices.

- > Run vaccination and parasite control programmes (especially for leptospirosis – refer to Guidelines for the Control of Occupationally Acquired Leptospirosis for more information).
- > Tell everyone working with animals about health and hygiene when working with cattle and in animal areas.
- > Make sure workers have a clean place to wash and dry their hands. It should include running water, liquid soap and a way to dry their hands, like paper towels. Buckets or troughs of water that are used by several people are not suitable. Use waterless alcohol-based hand rubs to sanitise visibly clean hands.
- > Tell people working with animals to wash their hands:
  - after touching cattle
  - after removing personal protective equipment (PPE)
  - when leaving animal areas
  - before eating and drinking
  - after accidental contamination with a cow's blood and body fluids.
- > After washing, it's just as important to thoroughly dry your hands to avoid getting sick.
- > Make sure children wash their hands properly.
- > Provide eating areas away from animal areas and stop workers from eating, drinking and smoking in animal areas.
- > Keep yards clean. Don't let manure build up.
- > Provide PPE to protect workers' clothing, skin and face from touching animal blood and body fluids. For example, disposable gloves for examining a cow's wound.
- > If using sharps, such as needles and syringes, carefully dispose of the sharps in a rigid-walled, puncture-resistant sharps container.
- > Tell workers not to touch areas (such as the muzzle) where saliva or snot can be transferred to a worker's face.
- > Tell anyone working with animals to cover cuts with a water-resistant dressing. If people are hurt at work, clean the wound properly and cover it with a water-resistant dressing.
- > Injured people should seek medical advice, particularly if they have a serious and/or open wound, or if they have a health condition that makes them more likely to become infected.
- > Isolate cattle showing signs of illness from people and other animals. Get the animal veterinary treatment as soon as is practical.
- > Call your vet and/or the MPI biosecurity hotline for any unknown or unfamiliar illness.
- > Carry out a pest control programme to discourage rats and other pests.



# 04/

---

## **PRINCIPLES OF SAFE CATTLE YARD DESIGN**

---

### **IN THIS SECTION:**

- 4.1 The site**
- 4.2 Orientation**
- 4.3 The benefits of steel yards**
- 4.4 Lighting**
- 4.5 Yard surface**
- 4.6 Pens**
- 4.7 Race, crush and head rail**
- 4.8 Loading**
- 4.9 Keep up your maintenance plan**
- 4.10 Plan long-term improvements**

---

Well-designed yards make it safer, not to mention easier, to manage cattle. If you're building new yards or adding to your existing yards, consider these principles of cattle yard design.

---

#### 4.1 THE SITE

Ideally, the site should be level and on a raised area. Think about the prevailing wind, which may carry strange smells and noises, making handling more difficult. Good drainage for working areas is best.

To make the site safe:

- > Clear overhanging trees and move telephone/power lines. When doing this consult an expert.
- > Make sure there's good access and space for trucks and trailers to move off the road safely, turn and back into the race.
- > Make sure there's enough space to handle stock safely.
- > If you're relocating yards, choose a site with a slight uphill slope, good drainage and dry ground.

> Put down a good layer of gravel or other all-weather surface.

> Check that your yards meet any local authority rules and regulations.

To improve drainage:

- > Vehicle access ways and stock areas should have a 100-150mm layer of coarse metal laid over a raised, well-drained base.
- > Install field or plastic drains. Otherwise, dig a drainage trench and fill it loosely with rubble.
- > Whatever drains you use, make sure they're below the surface to avoid trips and slips.

#### 4.2 ORIENTATION

Think about the main flow. A good design will 'draw' livestock through smoothly. It's better if cattle are not moved with low sun shining directly into their eyes.

#### 4.3 THE BENEFITS OF STEEL YARDS

Steel yards with concrete floors make handling cattle a lot easier and safer, especially steel head bails. However, they can be noisy - reduce the noise with well-placed bits of rubber.

Steel yards are rugged, they don't break, they're low maintenance and easy to clean. If you're building new or refitting your existing yards, steel yards are a good option.

#### 4.4 LIGHTING

Cattle yards should be well lit.

#### 4.5 YARD SURFACE

Surface cattle yards with material that lets people and animals move freely in all weather conditions. Metalled or concreted yards are preferable. Muddy yards are unsatisfactory. Make surfaces non-slip where possible.

SECTION 4.0 // PRINCIPLES OF SAFE CATTLE YARD DESIGN

**4.6 PENS**

To make pens safe:

- > Board out corners.
- > Make the pens adjustable so you can isolate stock in manageable numbers.
- > Have access gaps or flaps for a quick escape.

To make gates, hinges and latches safe:

- > Make gate latches secure, spring-loaded and fail-safe.
- > Thread top hinges with adjustable bolts through the posts. Fit strong, galvanised hinges designed for heavy gates.
- > Bolt a metal pin into each lunge hug securely to stop the gate from lifting out.
- > Invert safety hinges so the gate can't be moved.

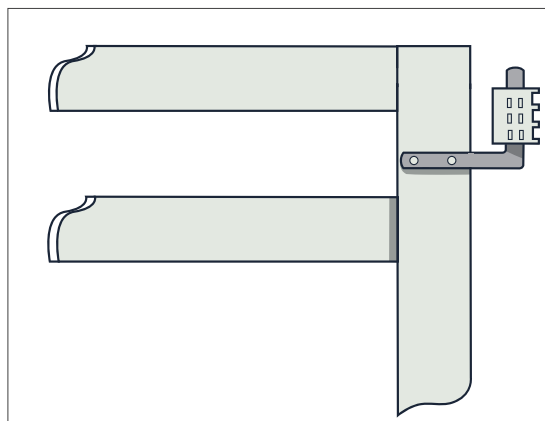

Figure 9: Inverted hinge

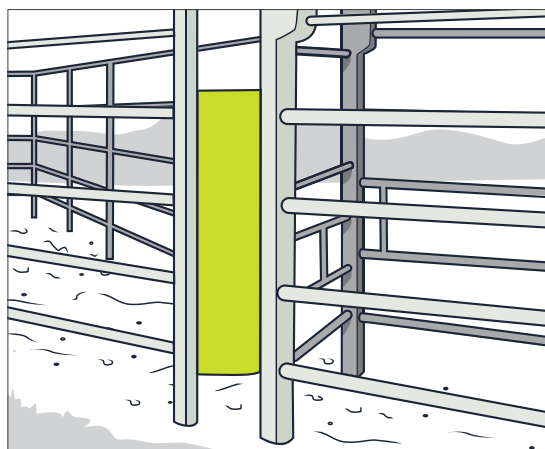
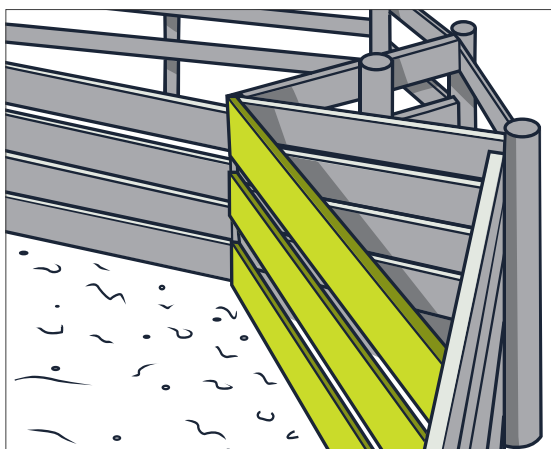

Figure 10: Pen with boarded out corner; Access gap

#### 4.7 RACE, CRUSH AND HEAD BAIL

Experience shows that cattle will move quietly and easily through a race up to a head bail or truck if the race is lined with plywood from top to bottom.

To make your races safe:

- > Make sure they're structurally strong.
- > Put down concrete or gravel surfaces.
- > Make them around 700mm wide.
- > Install non-slip catwalks for handlers.

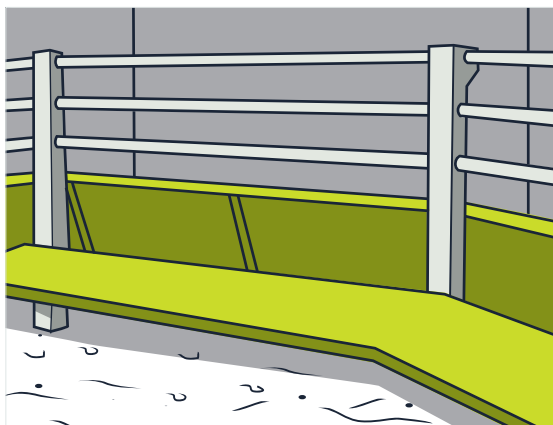

Figure 11: Catwalk

To make head bails safe:

- > Install them where there's a view to open space.
- > Make sure they close quickly, quietly and gently.
- > Avoid bars or gaps that could trap hooves.
- > Ensure they're solidly built, well-kept and can be removed easily for servicing.

Make rear race gates safe:

- > Fit them with self-closing latches to stop stock backing out of the race.
- > Make gates strong enough to stand up to stock movement.
- > Slide the slip rail completely through, in front of two adjacent posts.
- > For the rail, use a 50mm pipe (2 inches) up to 1.2m long.

#### 4.8 LOADING

The loading race should be the width of one animal. The sides should be solid (with no distractions to stop the cattle moving forward) and high enough to stop stock climbing out. Put down non-slip scored or stepped surfaces so the animals don't slip. The grain of rough sawn timber should run towards the front of the race.

Make the loading ramp 3–4.5 metres long with a 1 metre loading height for trucks. Allow a 75mm spacer, flush to the race to let truck doors open. Make sure the ramp is structurally strong.

It is best to have a flat landing at the top of the loading ramp because animals do not like to step from a stock crate directly onto a sloping ramp.

Install a catwalk with a non-slip surface (eg chicken wire) that lets you move safely and in the sight of animals.

#### 4.9 KEEP UP YOUR MAINTENANCE PLAN

If you're responsible for a cattle yard, you're responsible for keeping up a regular programme of maintenance:

- > Hammer nails home and flatten them off.
- > Saw down bolts so they're flush.
- > Fasten or replace loose timbers on catwalks or rails.
- > Maintain and lubricate the head bail and crush.
- > Keep gates well-oiled and free-swinging.
- > Cover catwalks with non-slip matting or chicken wire.
- > Look up. Make sure there are no branches or wires where the truck parks.
- > Lay down gravel in the approach-way.

#### 4.10 PLAN LONG-TERM IMPROVEMENTS

If you're responsible for a yard make sure safety is built in. Work out what needs doing and set up a plan. For example:

- > Lining an existing race with plywood significantly improves cattle flow through the race.
- > Replace or rehang gates so they swing freely.
- > Reverse the top gudgeon to prevent gates being lifted off.
- > Build catwalks on forcing pens, races and loading ramps.
- > Build in access slots, especially between the forcing pen and working area.
- > Make the race gate self-closing. Install self-closing latches and a tail bar.
- > Board up the forcing pen (at both sides of the race mouth) and the corners in pens.
- > Put a shelter over the working area and a ceiling over the weighing platform.
- > Divide large, square pens into longer, narrower ones.

- > Divide a long race by installing gates.
- > Concrete the floor of the race and forcing pen.
- > Install a good head bail and crush. Make sure livestock are drawn through by a clear view ahead.
- > Put a water trough in the yard.
- > Move the entrance gate at right angles to the fence-line, or uphill or on level ground so livestock aren't moving into the sun as they enter the yards.

If building or improving a yard, check:

- > it's structurally strong
- > there are catwalks along forcing pens, races and loading ramps
- > there are escape points and gates for emergency getaways
- > there's a way to hold movable ramps in place securely
- > there's water for stock
- > a good first-aid kit is available
- > catwalks are secure and safe.



# 05/

---

## **TRAINING REQUIREMENTS**

---

### **IN THIS SECTION:**

- 5.1 General requirements**
- 5.2 Children**
- 5.3 Training for health and safety representatives**

---

Handling cattle safely is a skill that comes with time and experience. Skilled cattle handlers understand how cattle behave and react. They know where to stand and how to move. They work together and get cattle to do what they want – quietly, smoothly and safely.

---

### 5.1 GENERAL REQUIREMENTS

People handling cattle must be well trained so they can:

- > care for the cattle
- > maintain animal welfare and production standards
- > avoid being hurt.

Farm owners, managers and employers must ensure that anyone handling cattle has enough experience, or is trained and supervised so no-one is put at risk.

In general, farmers need to:

- > do an induction for new employees – show them around the farm and tell them about hazards and safety procedures
- > identify what skills, knowledge or competencies employees need to do each task
- > have ways to train employees – for example, use external training providers or do on-farm instruction
- > make sure people only do the work if they're trained and/or properly supervised
- > keep records of employee training and instruction, identifying which jobs each employee can and can't do.

### 5.2 CHILDREN

Children are at much greater risk compared to adults because they don't have the skills and experience to understand risks or hazards.

Children will mainly learn safe animal handling practices through helping their parents or other competent adults. You can control the amount of risk children face by supervising them at all times.

Very young children (ie under 5) are at great risk around cattle and should not enter yards or paddocks unless with an adult. They must not do any 'work activity'.

### 5.3 TRAINING FOR HEALTH AND SAFETY REPRESENTATIVES

The Health and Safety in Employment Act 1992 gives employees the right to be involved in workplace health and safety matters.

One way to do this is by electing a health and safety representative. This is someone employees can go to when they have any concerns or suggestions about health and safety in the workplace. The representative will work with the employer in good faith to find a solution.

This representative can take two days paid leave each year to do approved health and safety training.

# 06/

---

## REFERENCES

---

### IN THIS SECTION:

- 6.1 Glossary
- 6.2 Bibliography



## 6.1 GLOSSARY

TERM	DEFINITION
<b>Acariasis</b>	A rash, caused by mites, sometimes with small raised bumps and it is usually very itchy.
<b>All Practicable Steps</b>	<p>‘The steps taken to achieve the result that it is reasonably practicable to take in the circumstances, having regard to—</p> <ul style="list-style-type: none"> <li>&gt; the nature and severity of harm that may be suffered if the result is not achieved; and</li> <li>&gt; the current state of knowledge about the likelihood and severity of harm that will be suffered if the result is not achieved; and</li> <li>&gt; the current state of knowledge about harm of that nature; and</li> <li>&gt; the current state of knowledge about the means available to achieve the results and about the likely effectiveness of each of those means; and</li> <li>&gt; the availability and cost of each of those means.</li> </ul> <p>‘To avoid doubt, a person required by the Health and Safety in Employment Act 1992 to take all practicable steps is required to take those steps only in respect of circumstances that the person knows or ought reasonably to know about.’</p> <p><i>Section 2A Health and Safety in Employment Act 1992</i></p>
<b>Balance Lines</b>	Imaginary lines running the length of a cow’s backbone and across its front shoulders. Moving through the balance line will cause the animal to move in the opposite direction.
<b>Campylobacter</b>	A type of bacteria that usually causes diarrhoea, cramping, abdominal pain and fever. The bug is one of the main causes of food poisoning in many developed countries.
<b>Cryptosporidiosis</b>	A microscopic parasite that can live outside a host for a long time. It causes diarrhoea. It is usually picked up from contaminated water.
<b>Crush</b>	A sturdy device designed to keep an animal still while animal handling or veterinary tasks are done.
<b>E. Coli</b>	A type of bacteria. Most E. coli strains are harmless, but some types can cause serious food poisoning.
<b>Flight Zone</b>	The area around an animal that, if you enter, will cause it to move.
<b>Forcing Pen</b>	The pen used to hold stock before moving them into the race.
<b>Gudgeon</b>	A socket-like, cylindrical (ie, female) fitting that goes over a ‘pintle’ (male fitting), allowing the parts to pivot or hinge.
<b>Head Bail</b>	A device usually placed in the race that is designed to trap an animal’s head and hold it; usually for routine animal handling or veterinary tasks (eg dehorning, ear-tagging, castration).
<b>Hock-Bar</b>	A bar placed through a race that is designed to allow an animal to step forwards over it, but stop them going backwards.
<b>Kick Rail</b>	A rail (usually in a milking shed) placed behind an animal’s rear legs to stop the animal from kicking people.

TERM	DEFINITION
<b>Leptospirosis</b>	A disease caused by bacteria ( <i>Leptospira</i> ). It affects both humans and other animals. Leptospiral infection in humans causes a range of symptoms, some very serious. But some infected people may have no symptoms at all.
<b>Listeriosis</b>	A bacterial infection. A person often gets diarrhoea or other gastrointestinal symptoms followed by a fever and muscle aches.
<b>Loading Race</b>	The race animals move through on their way to be loaded onto a truck for transport.
<b>Loading Ramp</b>	A ramp used to load animals onto a stock truck for transport.
<b>Milkers' Nodules</b>	A skin condition that is usually caught from the udders of infected cows. Milkers' nodule is caused by <i>Paravaccinia</i> virus. It looks like the orf skin disease in humans.
<b>Musculoskeletal disorders (work related)</b>	A collective name for a range of conditions that affect the muscles, tendons, bones and joints. This term includes occupational overuse syndromes, back injuries and acute low back pain.
<b>PPE</b>	Personal protective equipment, such as disposable gloves, helmet.
<b>Race</b>	A long, narrow pen in a stockyard that stock are forced through for drafting or other animal handling tasks.
<b>Rear Race Gate</b>	A gate at the rear of the race that stops stock from escaping the race.
<b>Ringworm</b>	A fungal infection of the skin in humans, pets (such as cats) and stock (such as sheep and cattle).
<b>Salmonella</b>	A type of bacteria that can infect the gut of humans and animals. Many salmonella infections are caused by eating contaminated food.
<b>Slip Rail</b>	A rail that can be placed behind cattle in a race to stop them backing up.
<b>Streptococcus</b>	A type of bacteria. It causes illnesses, such as strep throat, pink eye, meningitis, bacterial pneumonia, endocarditis (an inflammation in the heart), erysipelas (a skin infection) and necrotising fasciitis (a 'flesh-eating' skin infection).
<b>Waddy</b>	A long stick or length of pipe used to handle cattle.
<b>Zoonoses</b>	A disease that can pass between species, from cattle to humans or the other way around.

**6.2 BIBLIOGRAPHY****ACADEMIC PAPERS**

**Code of Practice for the Care & Handling of Beef Cattle: Review of Scientific Research on Priority Issues**, *Karen Schwartzkopf-Genswein, Joseph Stookey, Janice Berg, & John Campbell. Beef Code of Practice Scientists' Committee, National Farm Animal Care Council, 2012*  
[www.nfacc.ca/resources/codes-of-practice/beef-cattle/Beef\\_Cattle\\_Review\\_of\\_Priority\\_Welfare\\_Issues\\_Nov\\_2012.pdf](http://www.nfacc.ca/resources/codes-of-practice/beef-cattle/Beef_Cattle_Review_of_Priority_Welfare_Issues_Nov_2012.pdf)

**Working Safely with Livestock**, *Thomas Bean. Ohio State University Extension, 2008*  
[www.ag.auburn.edu/~schmisp/safety/working-safely-with-livestock.pdf](http://www.ag.auburn.edu/~schmisp/safety/working-safely-with-livestock.pdf)

**NEW ZEALAND GUIDANCE**

**Animal Welfare (Dairy Cattle) Code of Welfare 2010**, *National Animal Welfare Advisory Committee*  
[www.biosecurity.govt.nz/files/regs/animal-welfare/req/codes/dairy-cattle/dairy-cattle.pdf](http://www.biosecurity.govt.nz/files/regs/animal-welfare/req/codes/dairy-cattle/dairy-cattle.pdf)

**Animal Welfare (Painful Husbandry Procedures) Code of Welfare 2005**, *National Animal Welfare Advisory Committee*  
[www.biosecurity.govt.nz/files/regs/animal-welfare/req/codes/painful-husbandry/painful-husbandry.pdf](http://www.biosecurity.govt.nz/files/regs/animal-welfare/req/codes/painful-husbandry/painful-husbandry.pdf)

**Animal Welfare (Sheep and Beef Cattle) Code of Welfare 2010**, *National Animal Welfare Advisory Committee*  
[www.biosecurity.govt.nz/files/regs/animal-welfare/req/codes/sheep-beef-cattle/sheep-beef-cattle-code-2010.pdf](http://www.biosecurity.govt.nz/files/regs/animal-welfare/req/codes/sheep-beef-cattle/sheep-beef-cattle-code-2010.pdf)

**Animal Welfare (Transport within New Zealand) Code of Welfare 2011**, *National Animal Welfare Advisory Committee*  
[www.biosecurity.govt.nz/files/regs/animal-welfare/req/codes/transport-within-nz/transport-code-of-welfare.pdf](http://www.biosecurity.govt.nz/files/regs/animal-welfare/req/codes/transport-within-nz/transport-code-of-welfare.pdf)

**Handling Cattle Safely: No Bull Tips to Keep You out of Trouble**, *ACC, 2012*

[www.acc.co.nz/PRD\\_EXT\\_CSMP/groups/external\\_ip/documents/publications\\_promotion/wpc086521.pdf](http://www.acc.co.nz/PRD_EXT_CSMP/groups/external_ip/documents/publications_promotion/wpc086521.pdf)

**Sheep and Cattle Handling Skills: A Manual for New Zealand Conditions**, *Robert J. Holmes. ACC, 1984*

**Survival Guide for Livestock Handlers**, *Department of Labour, Federated Farmers NZ, Road Transport Forum, 2006*  
[www.acc.co.nz/PRD\\_EXT\\_CSMP/groups/external\\_ip/documents/guide/wim2\\_059364.pdf](http://www.acc.co.nz/PRD_EXT_CSMP/groups/external_ip/documents/guide/wim2_059364.pdf)

**GUIDANCE FROM OTHER JURISDICTIONS****Australia**

**Beef Cattle Handling: A Practical Safety Guide**, *WorkSafe Victoria, 2006*  
[www.worksafe.vic.gov.au/\\_\\_\\_data/assets/pdf\\_file/0015/12372/WSV1079\\_Beef\\_web.pdf](http://www.worksafe.vic.gov.au/___data/assets/pdf_file/0015/12372/WSV1079_Beef_web.pdf)

**Cattle Handling**, *Workplace Health and Safety Queensland*  
[www.deir.qld.gov.au/workplace/industry/agriculture/hazards/animal-handling/cattle-handling/index.htm#.Up7kltHxvug](http://www.deir.qld.gov.au/workplace/industry/agriculture/hazards/animal-handling/cattle-handling/index.htm#.Up7kltHxvug)

**Handling Cattle**, *Roy Hurst. NSW Department of Primary Industries, 2005 (reference: Agfact AO.1.2)*  
[www.dpi.nsw.gov.au/agriculture/livestock/beef/husbandry/general/handling-cattle](http://www.dpi.nsw.gov.au/agriculture/livestock/beef/husbandry/general/handling-cattle)

**Horse Riding Schools, Trail Riding Establishments and Horse Riding Establishments Code of Practice 2002**, *Workplace Health & Safety Queensland*  
[www.deir.qld.gov.au/workplace/resources/pdfs/horse-riding-cop-2002.pdf](http://www.deir.qld.gov.au/workplace/resources/pdfs/horse-riding-cop-2002.pdf)

### *Canada*

#### **Beef Cattle Handling Facilities,**

*Government of Saskatchewan, 2004*

[www.agriculture.gov.sk.ca/Default.aspx?DN=fd3df715-2548-4067-a0d9-895fb70d03a5](http://www.agriculture.gov.sk.ca/Default.aspx?DN=fd3df715-2548-4067-a0d9-895fb70d03a5)

#### **Code of Practice for the Care and Handling of Beef Cattle,**

*National Farm Animal Care Council, 2013 (Sections 4 Animal Husbandry and 4.1 Handling and Moving Cattle)*

[www.nfacc.ca/pdfs/codes/beef\\_code\\_of\\_practice.pdf](http://www.nfacc.ca/pdfs/codes/beef_code_of_practice.pdf)

#### **Livestock Handling,**

*National Education Center for Agricultural Safety, 2009*

[www.nsc.org/news\\_resources/Resources/Documents/Livestock\\_Handling.pdf](http://www.nsc.org/news_resources/Resources/Documents/Livestock_Handling.pdf)

#### **Occupational Health and Safety Guidelines for Farming Operations in Ontario,**

*Ministry of Labour, 2006 (Section 3 Large Animal Handling)*

[www.labour.gov.on.ca/english/hs/pubs/farming/gl\\_index.php](http://www.labour.gov.on.ca/english/hs/pubs/farming/gl_index.php) and [http://www.labour.gov.on.ca/english/hs/pubs/farming/gl\\_animal.php](http://www.labour.gov.on.ca/english/hs/pubs/farming/gl_animal.php)

### *Ireland*

#### **Guidance on the Safe Handling of Cattle on Farms,**

*Health and Safety Authority, Ireland, 2011*

[www.hsa.ie/eng/Publications\\_and\\_Forms/Publications/Agriculture\\_and\\_Forestry/Safe\\_Handling\\_of\\_Cattle\\_on\\_Farms\\_2011.pdf](http://www.hsa.ie/eng/Publications_and_Forms/Publications/Agriculture_and_Forestry/Safe_Handling_of_Cattle_on_Farms_2011.pdf)

### *United Kingdom*

#### **Are You Struggling with Cattle Handling?,**

*Health and Safety Executive*

[www.hse.gov.uk/agriculture/cattle\\_handling.htm](http://www.hse.gov.uk/agriculture/cattle_handling.htm)

#### **Farmwise,**

*Health and Safety Executive, 2nd ed., 2013*

[www.hse.gov.uk/pubns/books/hsg270.htm](http://www.hse.gov.uk/pubns/books/hsg270.htm)

#### **Handling and Housing Cattle,**

*Health and Safety Executive, 2012*

[www.hse.gov.uk/pubns/ais35.htm](http://www.hse.gov.uk/pubns/ais35.htm)

#### **Livestock,**

*Health and Safety Executive*

[www.hse.gov.uk/agriculture/topics/livestock.htm](http://www.hse.gov.uk/agriculture/topics/livestock.htm)

#### **Safe and Cost Effective Cattle Handling,**

*Red Meat Development Programme, Farming Connect, 2008*

[www.hccmpw.org.uk/medialibrary/publications/Nov%2008%20Cattle%20handling.pdf](http://www.hccmpw.org.uk/medialibrary/publications/Nov%2008%20Cattle%20handling.pdf)





---

## DISCLAIMER

WorkSafe New Zealand has made every effort to ensure that the information in this publication is reliable, but makes no guarantee of its completeness. WorkSafe New Zealand may change the contents of this guideline at any time without notice.

July 2014



Except for the logos of WorkSafe New Zealand, this copyright work is licensed under a Creative Commons Attribution-Noncommercial 3.0 New Zealand licence.

To view a copy of this licence, visit [creativecommons.org/licenses/by-nc/3.0/nz/](https://creativecommons.org/licenses/by-nc/3.0/nz/)

In essence, you are free to copy, communicate and adapt the work for non-commercial purposes, as long as you attribute the work to WorkSafe New Zealand and abide by the other licence terms.

---

**WorkSafe New Zealand**

56 The Terrace  
PO Box 165  
Wellington 6140

Phone: +64 4 897 7699

Fax: +64 4 415 4015

0800 030 040

[www.worksafe.govt.nz](http://www.worksafe.govt.nz)

[@WorkSafeNZ](https://twitter.com/WorkSafeNZ)

ISBN: 978-0-478-42522-2 (online)

ISBN: 978-0-478-42523-9 (print)